

POS	QTY	Article Number	DESCRIPTION
1	1	591606401	WET PICK-UP
2	1	591665901	COLLECTING BASKET
3	1	591692601	HANDLE
4	1	591910201	CABLE INLET, KIT
5	1	591910301	TANK, KIT
6	2	591768801	FINGER SCREW
7	2	591910401	WHEEL, KIT
8	1	591695501	TROLLEY
9	1	591910501	FRONT WHEEL, KIT
10	1	591910601	SECURING PLATE, KIT
11	1	591910701	TANK, COMPLETE
12	1	590469501	TANK INLET, COMPLETE
13	1	590469601	SCOOP
14	3	590396401	HOLDER, KIT
15	1	591790201	PLUG (GROUNDED)
16	1	591703401	PUMP
17	1	591910901	CHECK VALVE
18	1	591712501	HOSE COUPLING

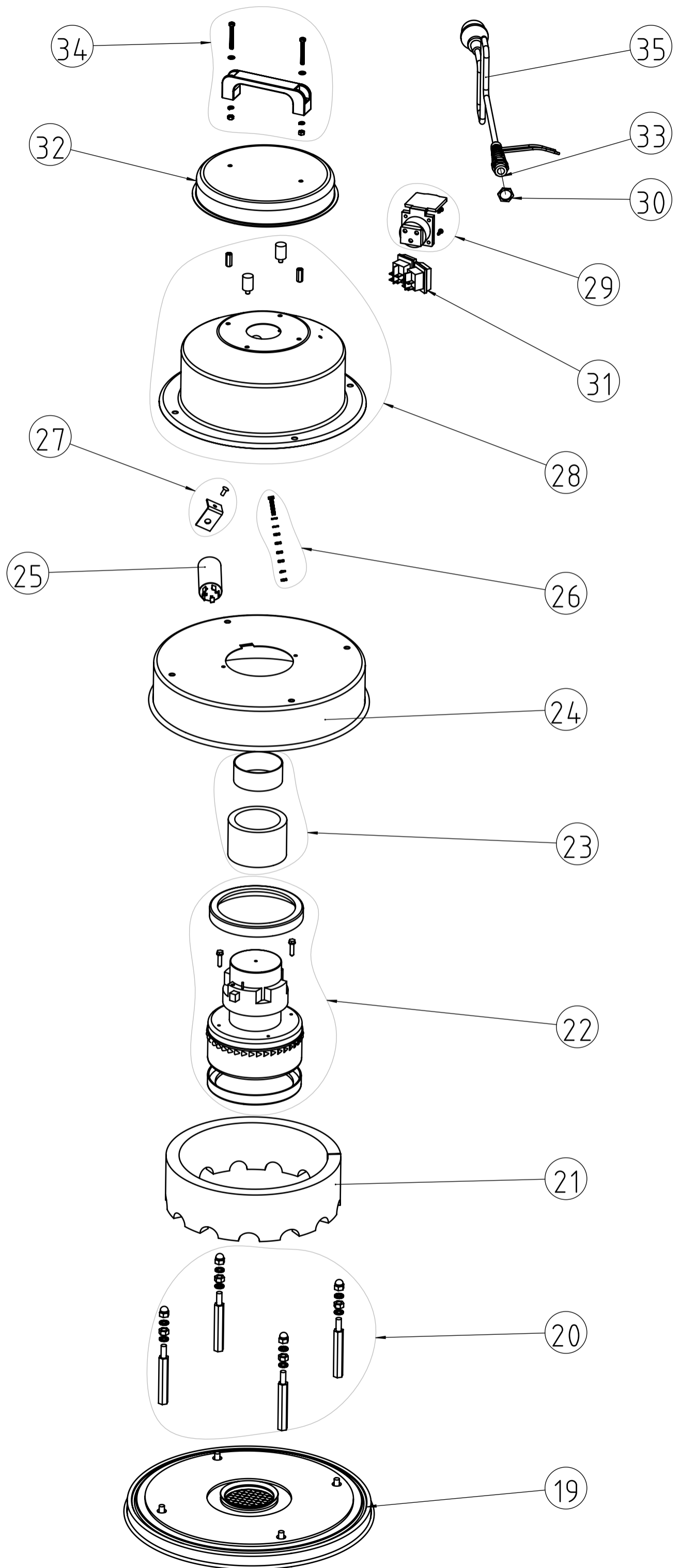

POS	QTY	Article Number	DESCRIPTION
19	1	591911001	CAN CAP, COMPLETE
20	1	590470301	SPACER, KIT
21	1	590469801	SOUND INSULATION
22	1	591906501	ENGINE, COMPLETE
23	1	590470401	SEALING, KIT
24	1	590498601	BLOWER CHAMBER, COMPLETE
25	1	591794301	ELECTRICAL FILTER
26	1	591906901	GROUND SCREW, KIT
27	1	591907001	ELECTRICAL FILTER HOLDER, KIT
28	1	591907501	DOMES, COMPLETE
29	1	590396301	ELECTRICAL OUTLET KIT
30	1	591789601	JAM NUT
31	1	590402601	SWITCH, KIT
32	1	590470601	CAP, COMPLETE
33	1	591791901	CABLE FIX
34	1	590470501	HANDLE, KIT
35	1	591784701	CORD SET